

My Phonics Coloring Book

mpi フォニックスめりえ

A says /a/, /a/, apple.



B says /b/, /b/, bear.



子ども英語のパイオニア
株式会社 mpi 松香フォニックス

① アルファベットを指さしながら
声に出していきましょう。

② 大文字と小文字をなぞりましょう。

③ むりえをしましょう。

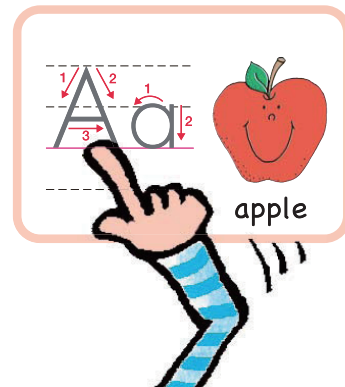

The Phonics Alphabet Jingle

フォニックスアルファベット・ジングルを
聞こう！ →→→



Phonics Alphabet

フォニックス
アルファベット



Listening



Speaking



Step 1

Listen, point to the pictures, and say the Phonics Alphabet Jingle.
CDを聞いて、絵をゆびさしながら、フォニックスアルファベット・ジングルを言おう。

Step 2

Say the Phonics Alphabet Jingle without looking at the textbook.
フォニックスアルファベット・ジングルを、本を見ないで言おう。

※ / は文字の音をあらわしています。



OoからZzまでも
見ないで言おう!



ルール アルファベットのそれぞれの文字には、「名前」と「音」がある。



A says /a/, /a/, apple. のようにぜんぶ言おう。

文字の名前

文字の音

キーワード



レッスンのたびに、
このジングルを言おう!



まずはNnまで
見ないで言えるように
なろう!



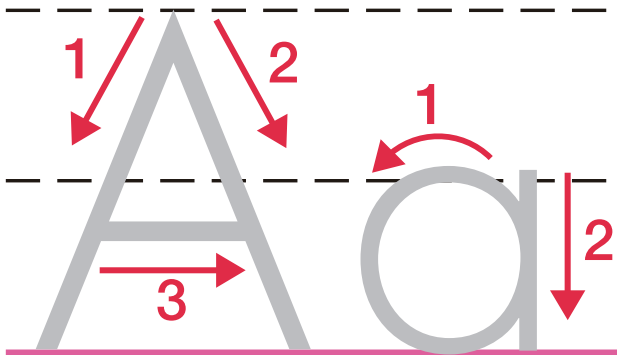

apple

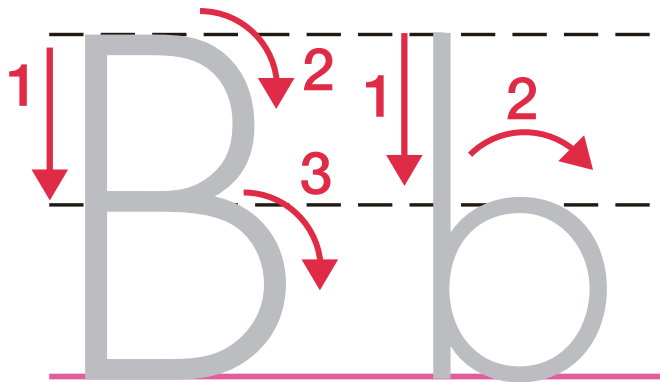

bear

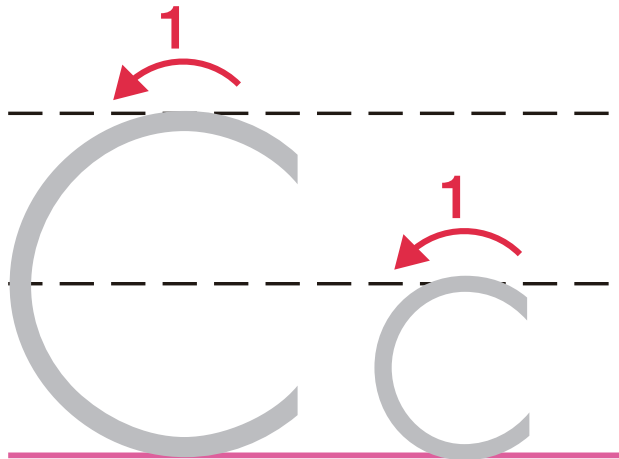

COW

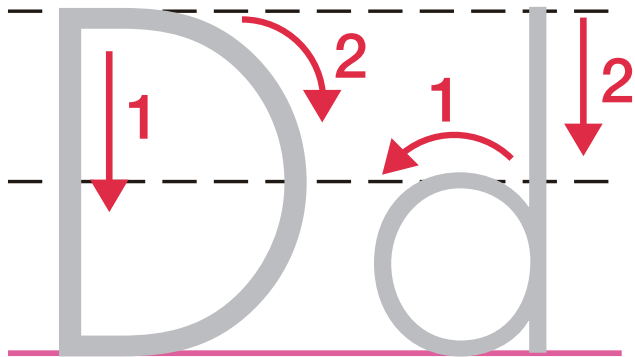

dog

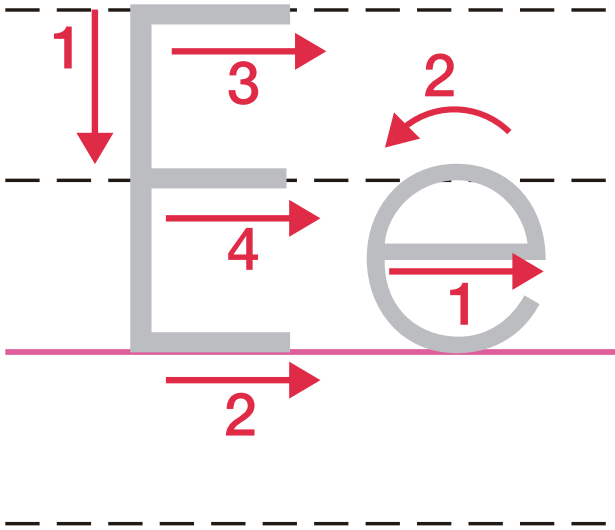

egg

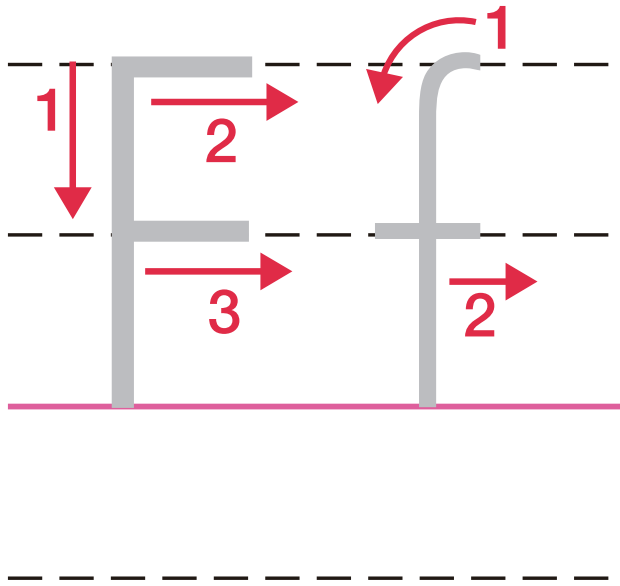

fish

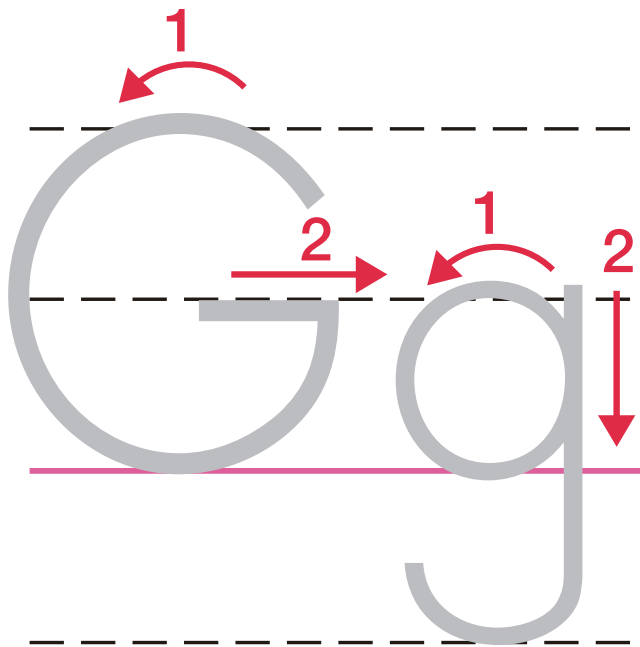

goat

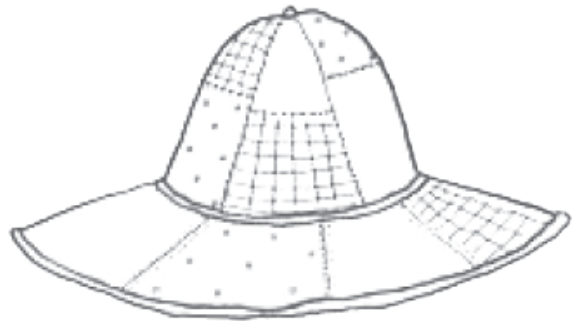
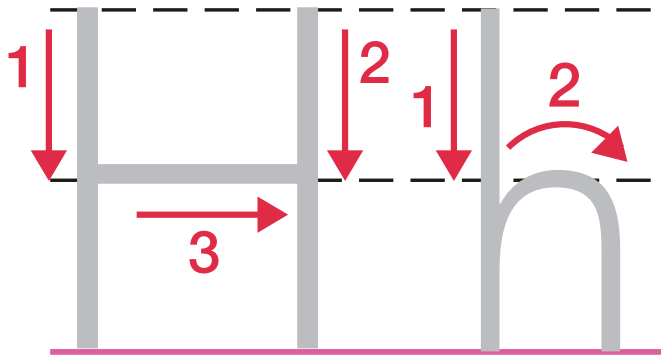

hat

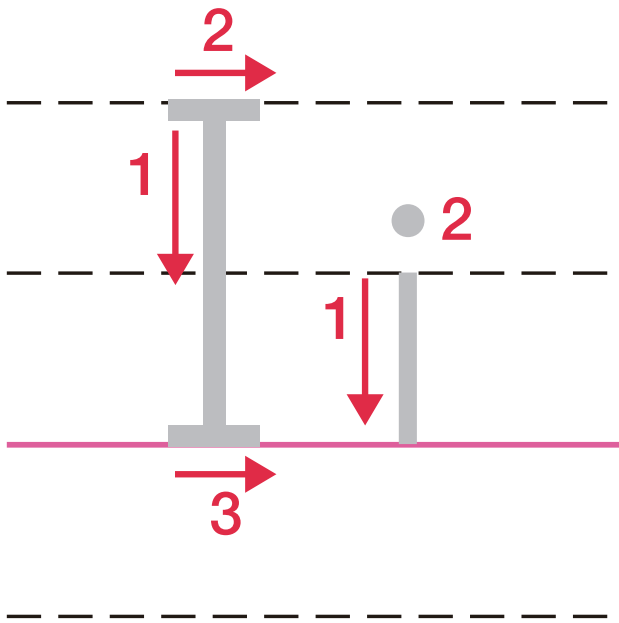

ink

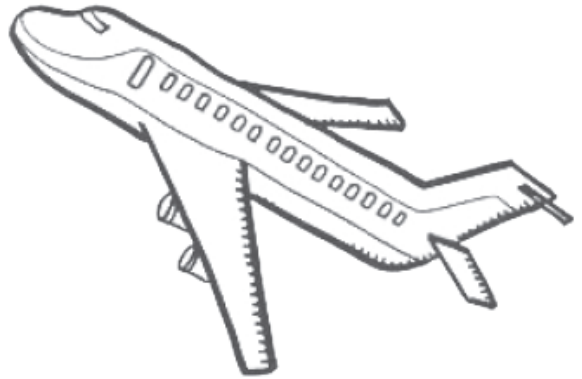
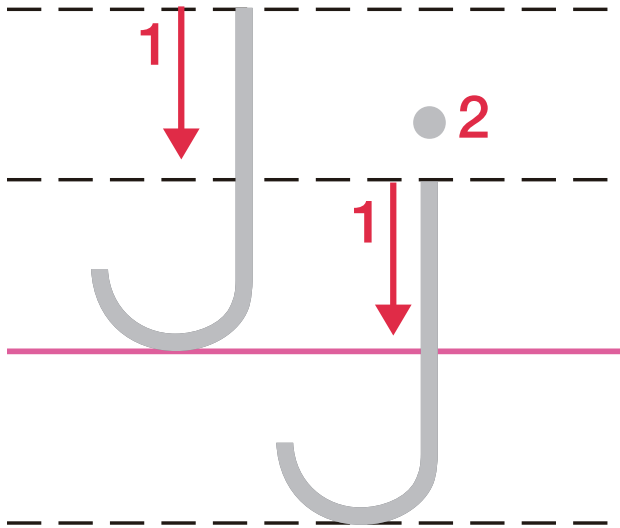

jet

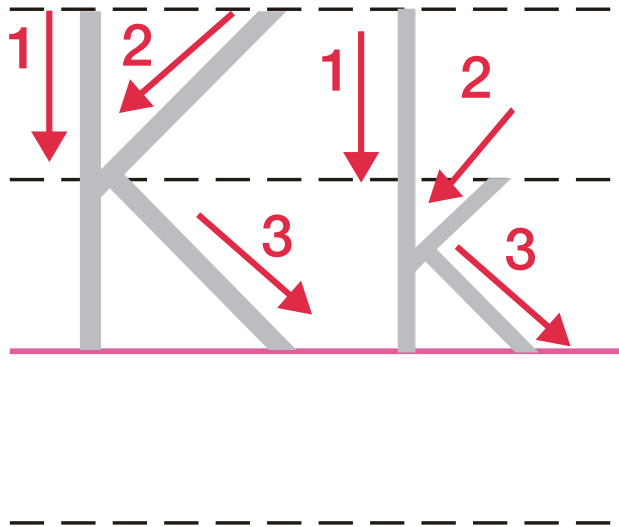

king

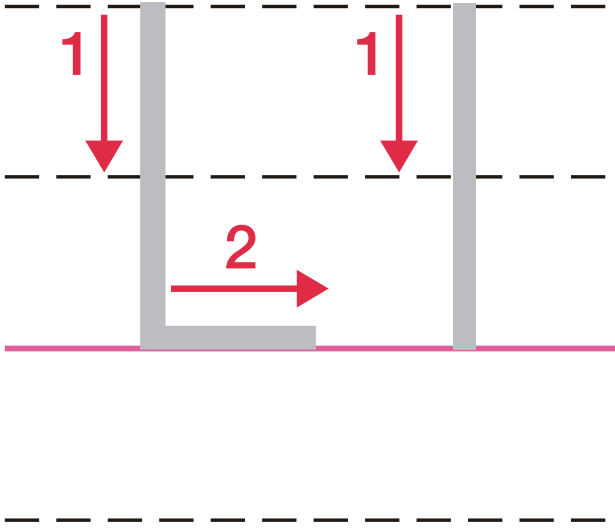

lion

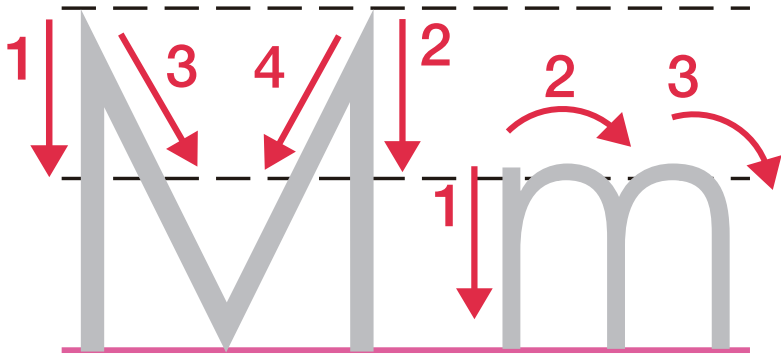

monkey

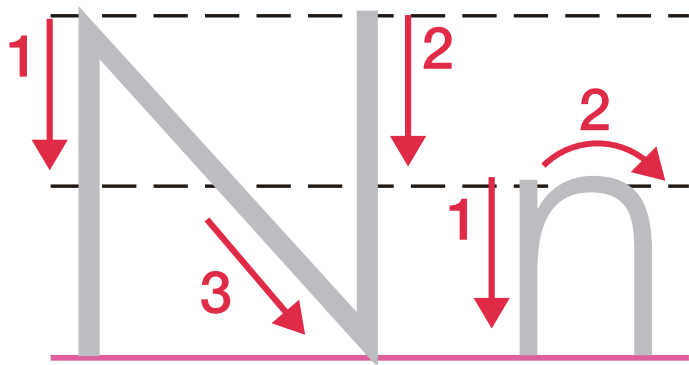

nest

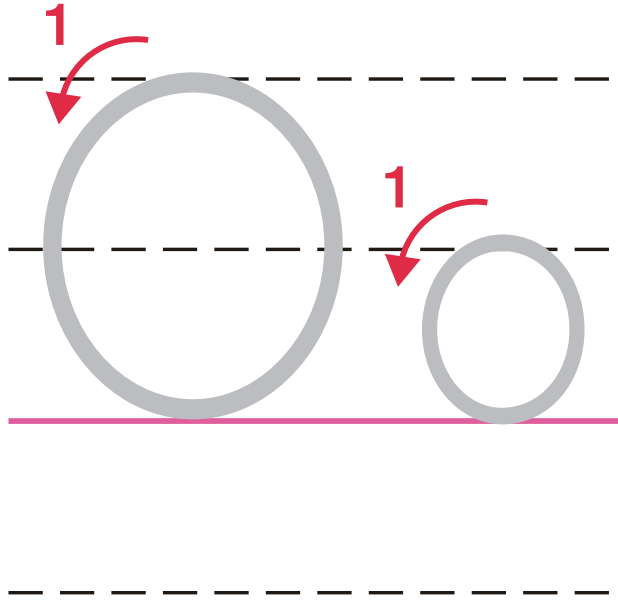

octopus

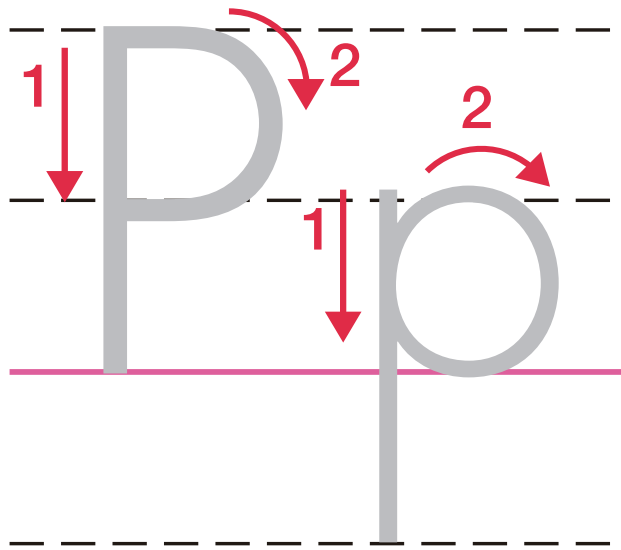

pig

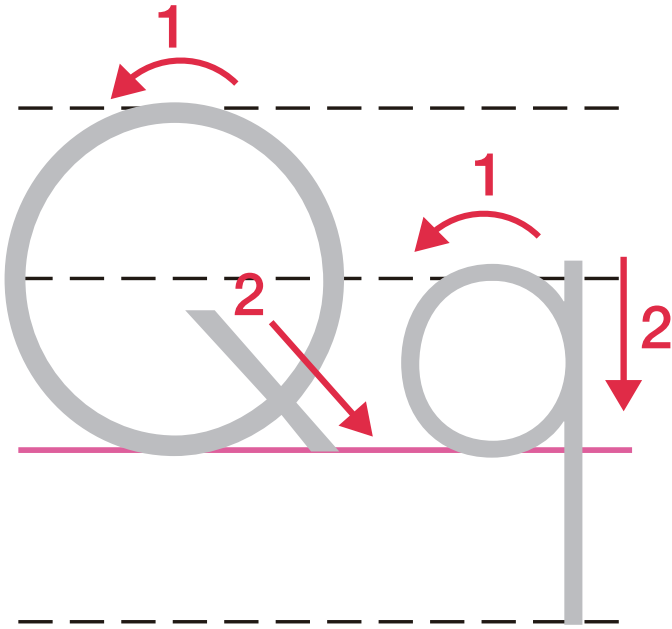

queen

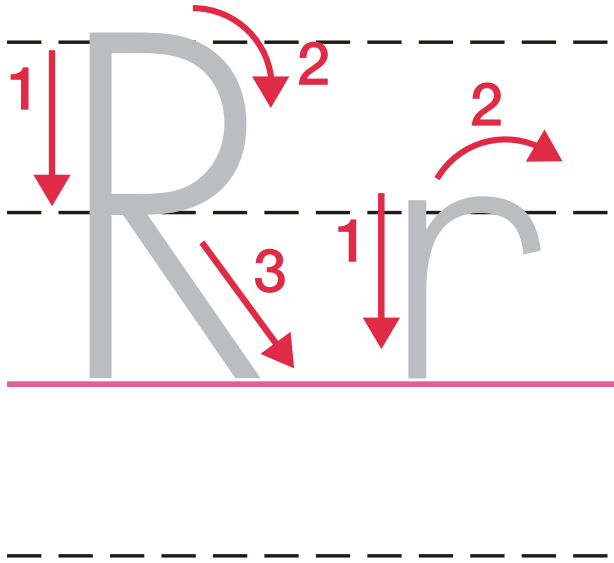

rabbit

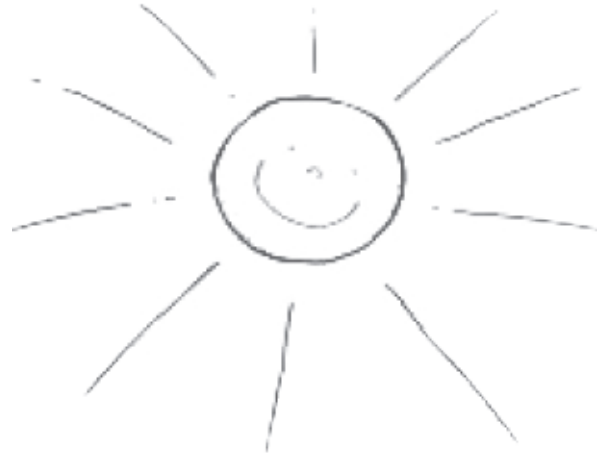
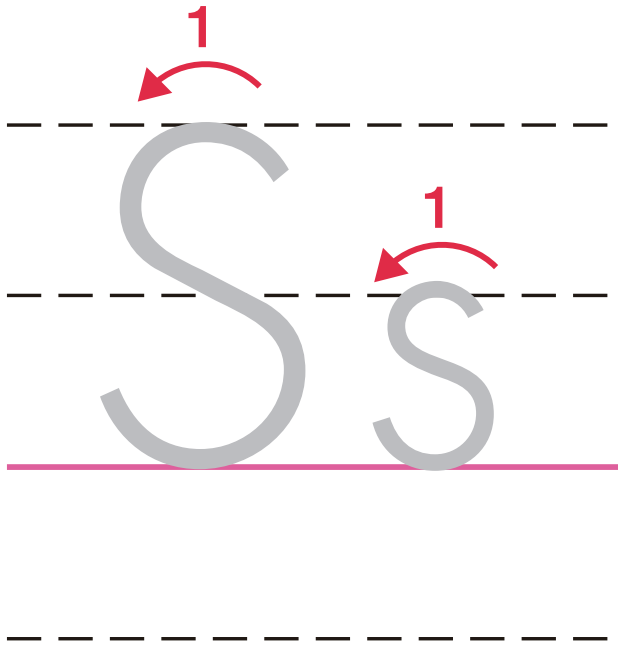

sun

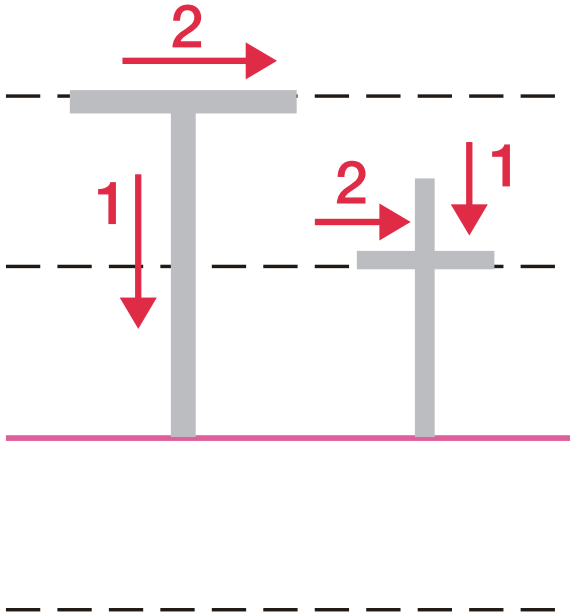

tiger

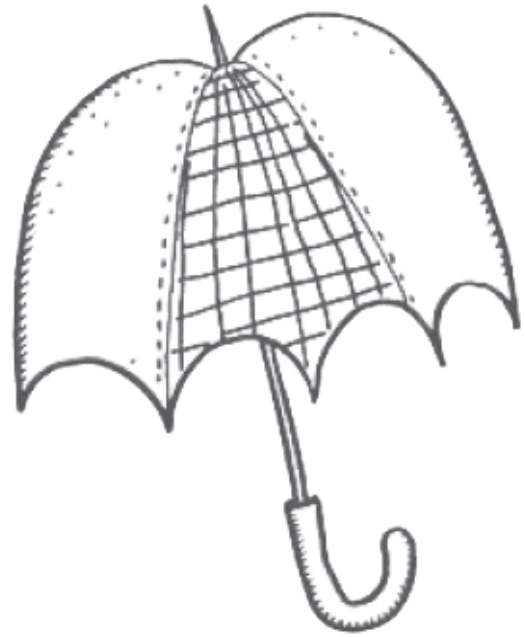
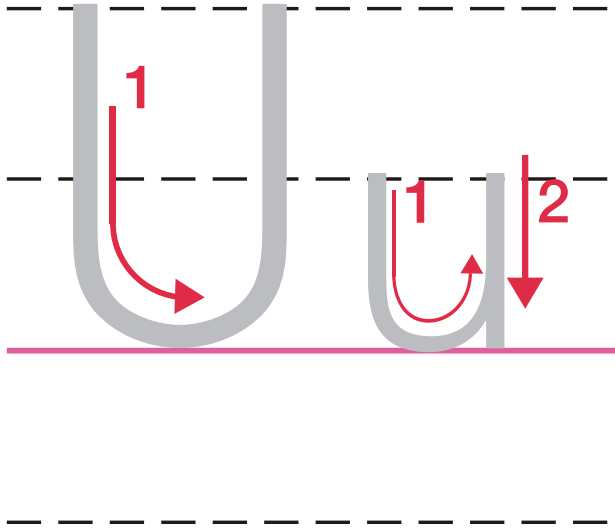

umbrella

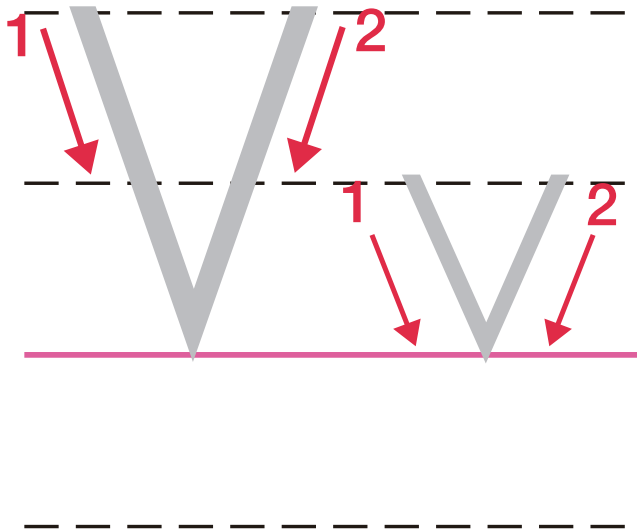

violin

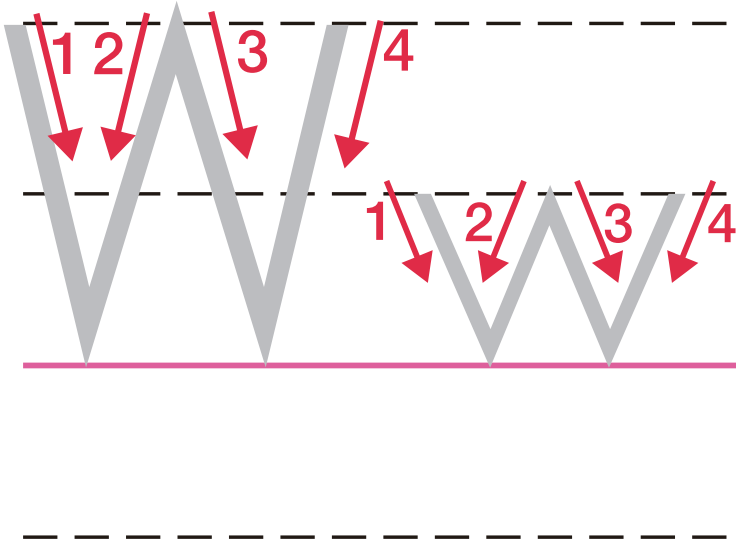

witch

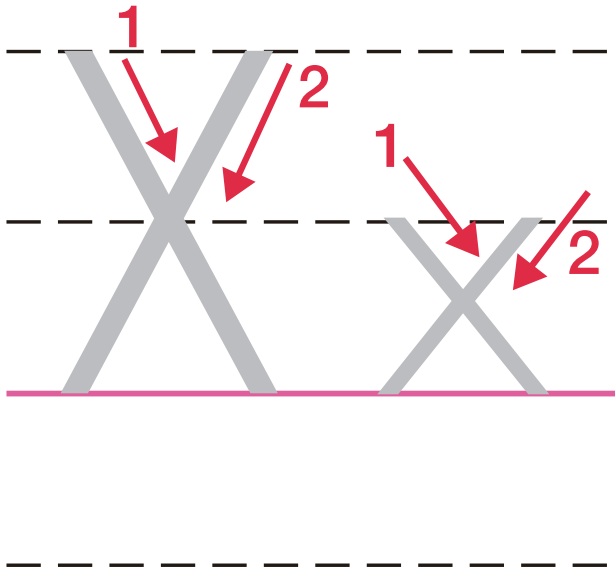

fox

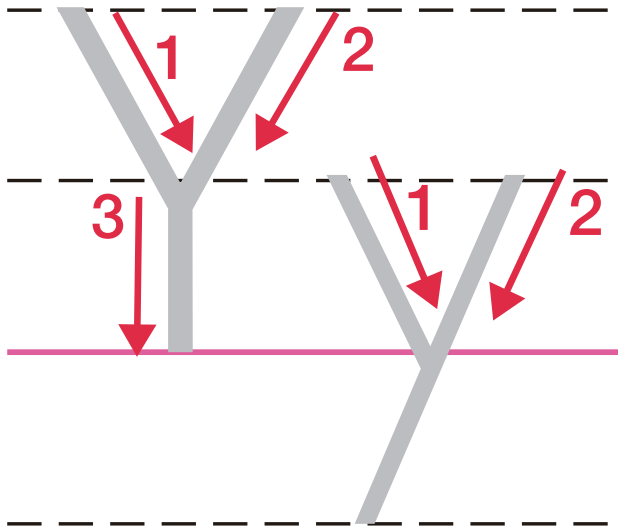

yard

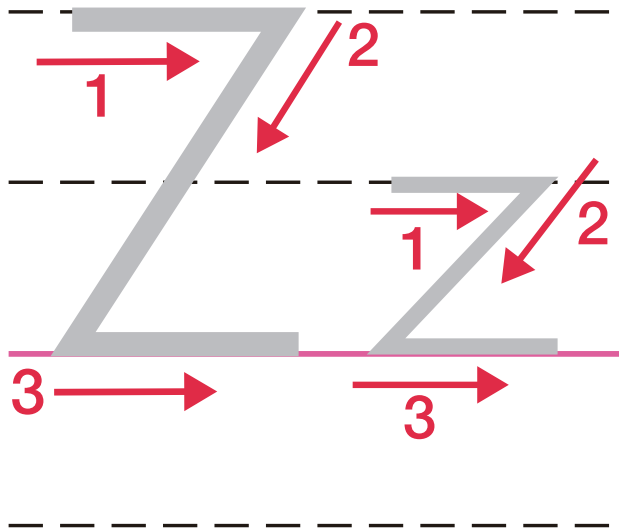

zebra

mpi の英語絵本の読み聞かせや 子ども英語教育のイベント



子ども英語のパイオニア

株式会社mpi松香フォニックス

▶▶▶▶▶▶▶▶▶▶ www.mpi-j.co.jp

〒151-0053 東京都渋谷区代々木2-16-2 甲田ビル2F
Phone: 03-5302-1651(代) Fax: 03-5302-1652

日本初! 英語教育口コミサイト
fumufumu 英語
www.fumufumueigo.net

mpi 公式 **facebook** @mpiinc
mpi 公式 **twitter** @mpiinc